

Dealer Name : _____
 Dealer Contact : _____
 Client Name : _____
 Scripting Date: ____/____/____
 Ship To : _____

Order N° _____ Quotation
 Date _____ Signature _____
 Customer Ref. _____ User weight Kg _____

Funding: _____
 Email Quote To: **PAGE 1/2**

2020, January

Key standard ○ option

ZODIAC

- L** Seat width 34 36 38 40 42 44
- P** Seat depth 36 38 40 42 44
- HS** Back-rest height 27 29 31 33 35 37 39
- HA** Front seat/floor height 46 48 50
- HP** Rear seat/floor height 40 42 44 46
- DP** Foot-rest/seat distance 35 37 39 41 43 45 47 49 cm

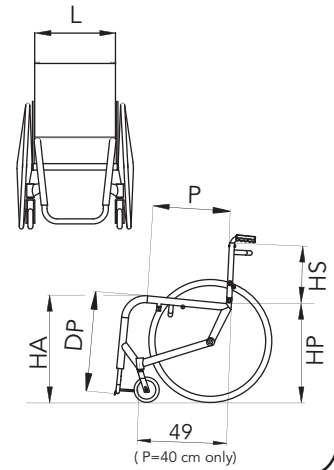

- Frame colour** ①
- Metallic grey Pearl white Matt black
 - Glossy black Cyclamen light purple
 - (see "Colours" catalogue)
 - Neon green Neon orange

- Upholstery** ②
- Tension adjustable nylon back-rest
 - Tension adj. breathable back-rest
 - Without back-rest for seating system:
 - SAMEKH**
 - other seating system:.....

Single tubular foot-plate ③

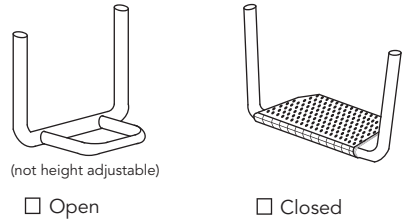

Pushing handles ④

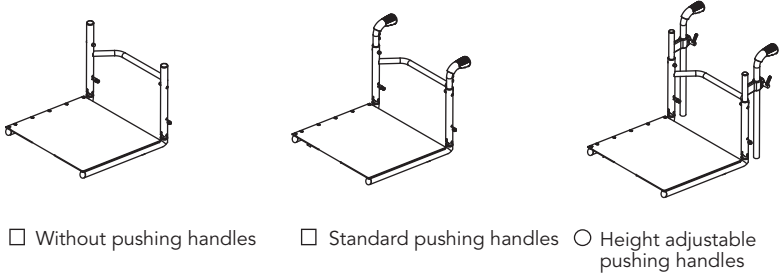

Distance between the hub centre and back-rest ⑤

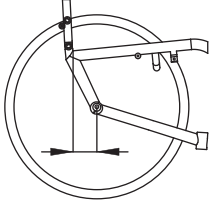

- 7 cm 13 cm
- 9 cm (standard) 15 cm
- 11 cm

Back-rest tilt ⑥

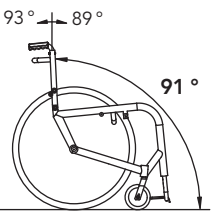

- 89°
- 91° (standard)
- 93°

Front angle ⑦

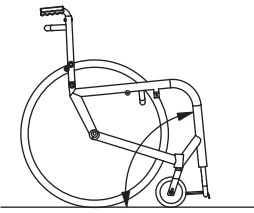

- 83° (standard) (A=16cm)
- 75° (A=23cm)

Rear wheel camber ⑧

- 1° 2°
- 3° 4°

Side guards ⑨

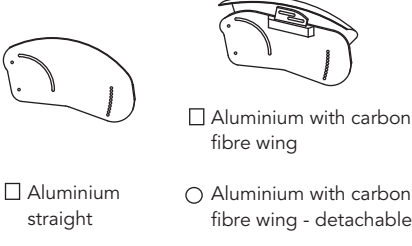

"L" arm-rest, detachable, h 22cm ⑩



- Tip-up
- Elbow-rest**
- Tubular
- Straight (26 cm long)
- Classic (23 cm long)
- Classic (30 cm long)

Brakes ⑪

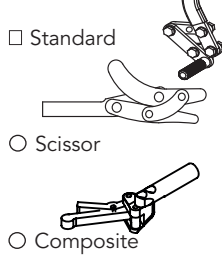

Revolving anti-tip device ⑫

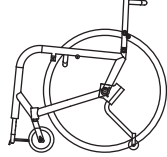

- Right
- Left

Notes



Dealer Name : _____
 Dealer Contact : _____
 Client Name : _____
 Scripting Date: ____ / ____ / ____
 Ship To : _____

Order N° _____ Quotation
 Date _____ Signature _____
 Customer Ref. _____

Funding: _____
 Email Quote To: _____



PAGE 2/2

ZODIAC

Dealer

2020, January

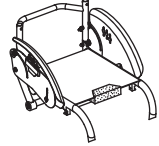
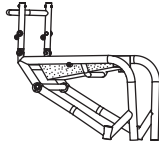
Rear wheels ⑫ <input type="checkbox"/> 24" Light(24 spokes) <input type="checkbox"/> 24" Star 6x3 (18 spokes, black or silver) <input type="checkbox"/> 24" (36 spokes) <input type="checkbox"/> 24" Mountain-bike with Citybike tyre <input type="checkbox"/> 24" Mountain-bike with Offroad tyre <input type="radio"/> 24" Ultralight (24 spokes) black <input type="radio"/> 24" Spinergy _____ spokes colour.....(black std) <input type="radio"/> 25" Spinergy _____ spokes colour.....(black std) <input type="radio"/> 25" Light (24 spokes) black Tyres <input type="checkbox"/> Pneum. Marathon Plus <input type="checkbox"/> Pneum. high pressure Smooth <input type="checkbox"/> Pneum. high pressure Plugged 24" <input type="checkbox"/> Pn.Schwalbe Right Run 24" <input type="radio"/> Solid 24" not available for Ultralight wheels	Pushrims ⑬ <input type="checkbox"/> Aluminium silver <input type="checkbox"/> Aluminium dark <input type="radio"/> Chromium-plated steel 24" <input type="radio"/> Rubber coated <input type="radio"/> Titanium <input type="radio"/> CarboLife CURVE L 24" * <input type="radio"/> CL Curve L TetraGrip 24" * <input type="radio"/> CL Quadro rubber ctd 24" * <input type="radio"/> CarboLife GEKKO 24" * <input type="radio"/> Silicon covers 24" <small>* not suitable for Star 6x3 and Mountainbike wheels</small>	Spoke guards ⑭ <input type="radio"/> Transparent 24" <input type="radio"/> Black 24" <input type="radio"/> Alphabet 24" <input type="radio"/> Fantasy code pattern (see catalogue of spokeguards) <div style="border: 1px solid black; padding: 5px; margin: 10px 0;"> Lined cushion in foam polyurethan ⑯  <input type="radio"/> 3 cm high <input type="radio"/> 5 cm high </div>	Front castors ⑮ <input type="checkbox"/> 80 (3") solid <input type="radio"/> 80 (3") solid with lights <input type="checkbox"/> 100 (4"x1.1/4) solid with plastic rim <input type="radio"/> 100 (4"x1) solid with lights <input type="checkbox"/> 100 (4"x1.1/4) solid with alum. rim <input type="checkbox"/> 125 (5"x1.1/4) solid with plastic rim <input type="checkbox"/> 125 (5"x1.1/4) solid with alum. rim <input type="radio"/> 125 (5"x1) solid with lights
--	---	---	---

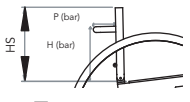
Pockets ⑰  <input type="checkbox"/> Small under the seat  <input type="radio"/> Big under the seat  <input type="checkbox"/> On the back-rest	Backrest bar ⑱  <input type="checkbox"/> Standard: P(bar) 7,5cm; H(bar) 19cm; dia 19mm. <input type="checkbox"/> Custom: P.....cm; H.....cm; dia.....mm.	Options 20 <input type="checkbox"/> "M+F" velcro strips (hook and loop) on seat 21 <input type="checkbox"/> "M" velcro strips (hook) on seat 22 <input type="checkbox"/> "F" velcro strips (loop) on seat 23 <input type="checkbox"/> Padded rigid seat h 5 24 <input type="radio"/> Chest harness 25 <input type="radio"/> Chest belt 26 <input type="radio"/> Abductor belt 27 <input type="radio"/> Catheter holder pocket 28 <input type="radio"/> Rx <input type="radio"/> Lx Crutch holder 29 <input type="radio"/> Pump for pneumatics 30 <input type="radio"/> Suitcase holder 31 <input type="radio"/> 45° pelvic belt 32 <input type="radio"/> 45° padded pelvic belt 33 <input type="radio"/> Black backpack 34 <input type="radio"/> Umbrella holder 35 <input type="radio"/> Front protective covers
Anodized set ⑲ (Rear wheel rims & hubs if LIGHT 24", forks and fittings) <input type="checkbox"/> Black <input type="checkbox"/> Silver <input type="radio"/> Light blue <input type="radio"/> Red <input type="radio"/> Orange <input type="radio"/> Cyclamen light purple <small>(only 24" Light wheels)</small>		

Notes
